

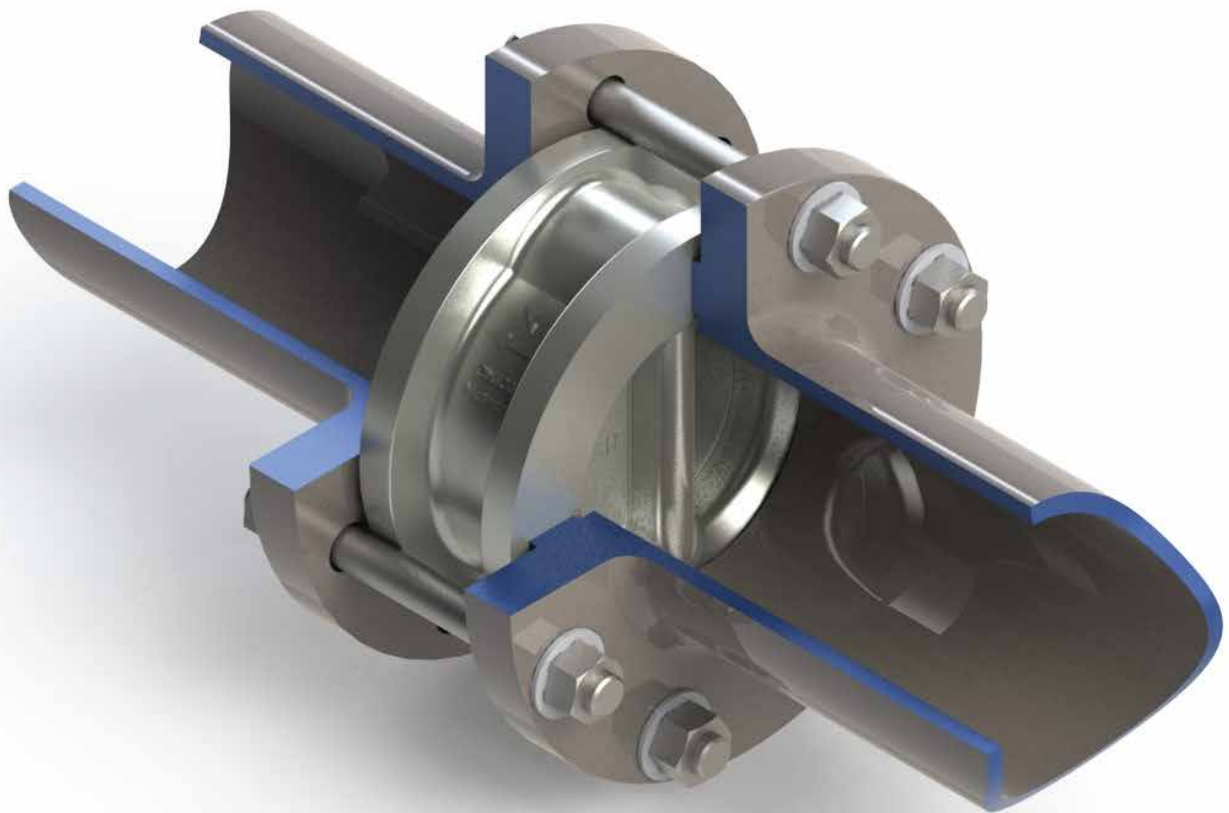

# ABACUS

Abacus Valves International Ltd



MEMBER OF  
**BVAA**



[www.abacusvalves.com](http://www.abacusvalves.com)

part of THE  
**GLEN FOUNDRY**  
GROUP

# Company Profile



Established in 1988 to design, manufacture and supply wafer check valves to the energy and process industries, Abacus Valves is part of The Glen Foundry Group, which incorporates internationally established engineering companies Anderson Stewart Castings Plc and Precision Tooling Services Ltd.

With our commitment to meeting customers needs, Abacus supplies cost effective solutions on time. A wide range of standard products are stocked at our UK base and are available on short lead times.

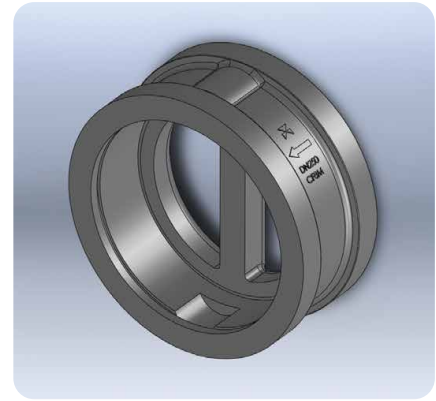

## Resources & Facilities

The close relationship of the three companies ensures that the high integrity (ferrous and non-ferrous) investment casting skills and knowledge of Anderson Stewart, coupled with the leading edge manufacturing and inspection facilities of Precision Tooling Services, perfectly compliment the Abacus products. Further investment at Abacus has significantly upgraded in-house pressure test facilities and CAE software.

## Design & Development

Using the latest 3D CAE techniques, our valves are modelled and analysed to ensure optimum up front design. Abacus has fully integrated 3D CAD, Finite Element Analysis (FEA) and Computational Fluid Dynamics (CFD) capabilities. We utilise our extensive experience and combine with modern simulation techniques to enable us to meet the individual demands of any scenario. We apply innovation and a flexible, solution driven approach to working with our customers and end users, continually improving our designs and developing new products.

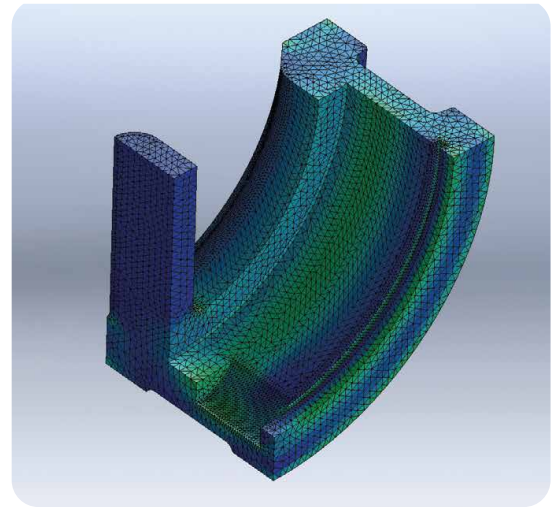

## Quality

All three companies incorporated by The Glen Foundry Group are ISO 9001 accredited.

## Sales

Commercial and technical assistance is available through our internal and external sales team. With vast experience in the valve industry, on-site technical assistance can be provided when required.



## Typical Products (Specials available on request)

Abacus products are available in a wide range of materials including:  
Stainless Steels (Austenitic, Martensitic and Duplex), Carbon Steels (LCB, LCC, WCB),  
Hastelloy™, (Nickel Alloy), Monel™ (Nickel Alloy), Titanium, Cast Iron and Plastics (PTFE, PVC, PP, PVDF).

### Twin Plate Wafer Check Valves



- Available in wide range of sizes from DNO40 – 1800 with ratings up to ANSI 2500.
- Wafer, solid lugged, flanged, retainerless, long pattern, short pattern, resilient or metal seated variations available.

### Swing Type Wafer Check Valves

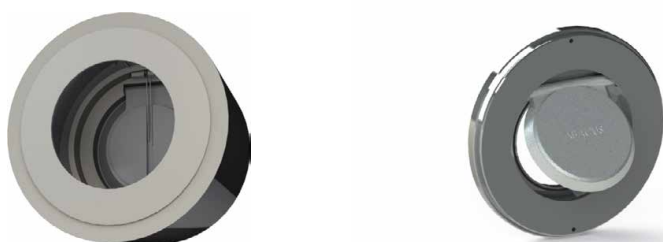

- Available in wide range of sizes from DNO15 – 1800 with ratings up to ANSI 2500.
- Long pattern, short pattern, full bore, spring return, resilient or metal seated variations available.

### Sprung Disc Wafer Check Valves



- Available in wide range of sizes from DNO15 – 300 with ratings up to ANSI 2500.
- Long pattern, short pattern, lined, resilient or metal seated variations available.

### Nozzle Check Valves



- Available in wide range of sizes from DNO15 – 600 with ratings up to ANSI 2500.
- API 6D face-to-face, manufacturers face-to-face, resilient or metal seated variations available.

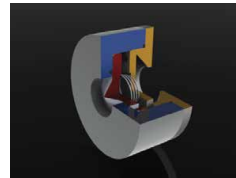
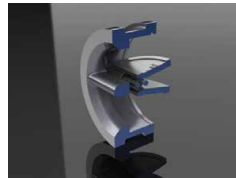

Abacus Valves International Ltd  
 Block 4 Riverside Road Paddockholm Industrial Estate Kilbirnie KA25 7EW  
 T. +44 (0)1505 681 777 F. +44 (0)1505 683 999  
 E. [sales@abacusvalves.com](mailto:sales@abacusvalves.com) [Sales] [documentation@abacusvalves.com](mailto:documentation@abacusvalves.com) [Quality Department]  
[admin@abacusvalves.com](mailto:admin@abacusvalves.com) [Expediting] W. [www.abacusvalves.com](http://www.abacusvalves.com)



[www.abacusvalves.com](http://www.abacusvalves.com)

 [www.facebook.com/abacusvalves](https://www.facebook.com/abacusvalves)

 [www.twitter.com/abacusvalves](https://www.twitter.com/abacusvalves)

THE  
**GLEN FOUNDRY**  
 GROUP

**Anderson Stewart**

Manufacturers of Precision Investment Castings

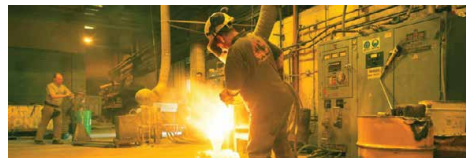

Anderson Stewart Castings Plc  
 Block 1 Units 1 & 2 Lochshore East Industrial Estate Glengarnock KA14 3DB  
 T. +44 (0) 1505 683 368 F. +44 (0) 1505 683 771  
 E. [mail@ascast.co.uk](mailto:mail@ascast.co.uk) W. [www.andersonstewartcastings.co.uk](http://www.andersonstewartcastings.co.uk)



Precision Tooling Services Ltd  
 Building 11a Spirit AeroSystems Europe Ltd Prestwick International Airport Prestwick KA9 2RW  
 T. +44 (0) 1292 678 479 F. +44 (0) 1292 678 650  
 E. [general@precision-tooling.co.uk](mailto:general@precision-tooling.co.uk) W. [www.precision-tooling.co.uk](http://www.precision-tooling.co.uk)